

AM-980L

Electric Actuator for 9800, 980F, 9880 and 988F Valves Series



Via Circonvallazione, 10
13018 Valduggia (VC), Italy
Tel: +39 0163 47891
Fax: +39 0163 47895
www.vironline.com



Electric actuator with ISO 5211 connection
Fast bayonet connection with ring for F04-□9mm
Travel 90°, in 5 to 120 seconds
Manual override
With 1m electric wire
Enclosure protection IP44-IP54 according EN 60529
Torque max. from 6Nm to 10Nm
CE compliant

Available on following versions:

- 2 points control, 230VAC
- 2 points control, 24VAC
- 2/3 points control, 24VDC
- 0-10V control signal, 24V AC/DC

Working ambient temperature: 0° to +50°C (RH 5%-80%, no condensation)



TECHNICAL DATA

VIR Code	P. Supply	Control	Torque	Travel Time [sec]	Auxiliary switch
KAM980L00.800	230VAC	2 punti	10Nm	30"	NO
KAM980L01.800	230VAC	2 punti	10Nm	30"	YES
KAM980L02.800	24VAC	2 punti	10Nm	30"	NO
KAM980L03.800	24VAC	2 punti	10Nm	30"	YES
KAM980L04.800	24VDC	3 punti	6Nm	5"	YES
KAM980L05.800	24VAC/DC	0-10V	10Nm	60"	YES
KAM980L06.800	230VAC	3 punti	10Nm	30"	NO
KAM980L07.800	230VAC	3 punti	10Nm	30"	YES

DIMENSIONS

Dimensions in mm, wight 0,5Kg

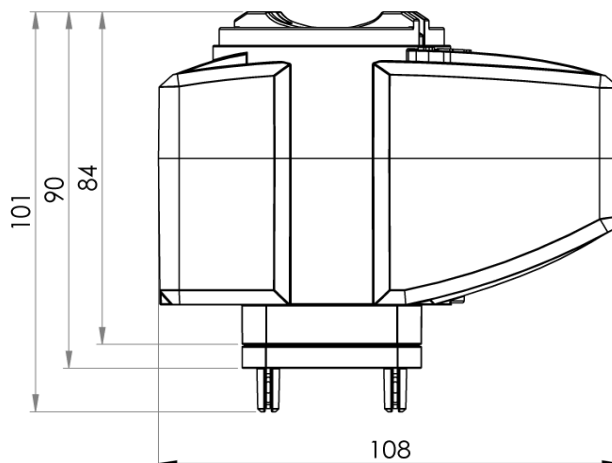
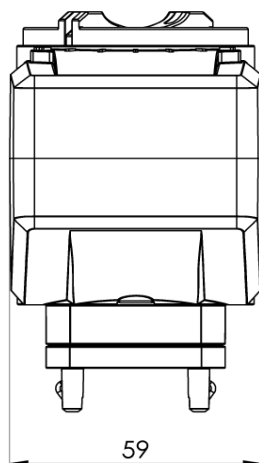

WIRING DIAGRAMS

Ref.	Designation
N	Wiring to neutral
Ph	Wiring to phase
+	Wiring to + pole
-	Wiring to - pole

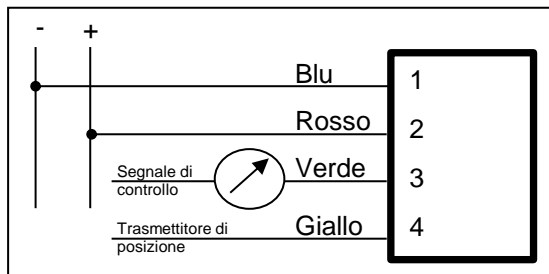

Control signal 0-10V
KAM980L05.800

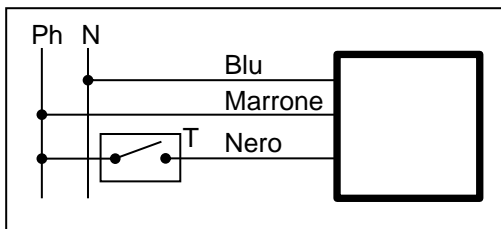

2 points control
KAM980L00.800 - KAM980L02.800

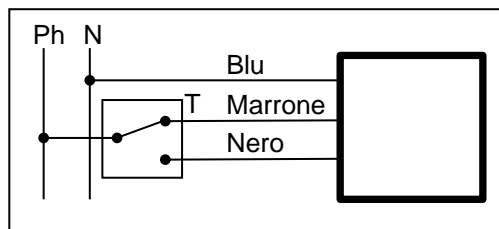

3 points control
KAM980L06.800

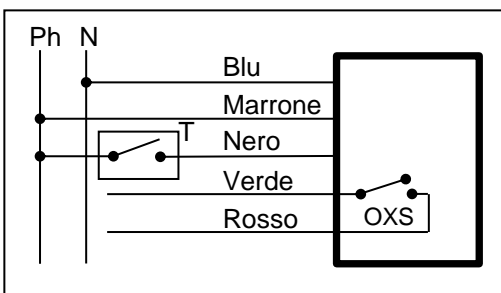

2 points control + 1 auxiliary switch
KAM980L01.800 - KAM980L03.800

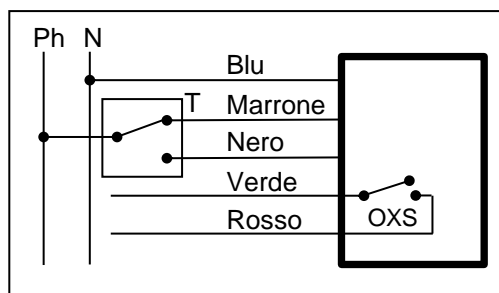

3 points control + 1 auxiliary switch
KAM980L04.800 - KAM980L07.800

INSTALLATION

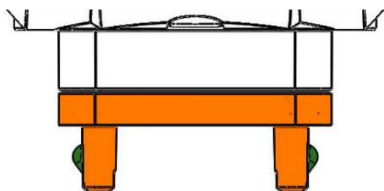

Quick coupling system for ISO -5211 valves which allows the connection of the actuator to the valve quickly, easily and without the use of tools.

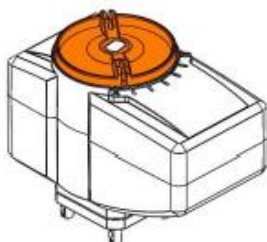
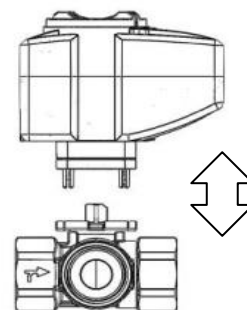
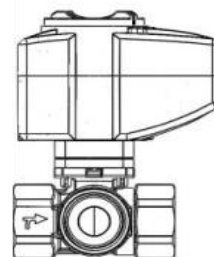
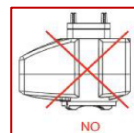

Integrated manual release system that allows you to move the valve with one hand, without the need to disconnect the actuator from the valve and without the use of tools.



®

Via Circonvallazione, 10 13018 Valduggia (VC), Italy Tel: +39 0163 47891 Fax: +39 0163 47895 www.vironline.com