

# AM-980L

Electric Actuator for 9800, 980F, 9880 and 988F Valves Series



Via Circonvallazione, 10  
13018 Valduggia (VC), Italy  
Tel: +39 0163 47891  
Fax: +39 0163 47895  
www.vironline.com



Electric actuator with ISO 5211 connection  
Fast bayonet connection with ring for F04-□9mm  
Travel 90°, in 5 to 120 seconds  
Manual override  
With 1m electric wire  
Enclosure protection IP44-IP54 according EN 60529  
Torque max. from 6Nm to 10Nm  
CE compliant

Available on following versions:

- 2 points control, 230VAC
- 2 points control, 24VAC
- 2/3 points control, 24VDC
- 0-10V control signal, 24V AC/DC

Working ambient temperature: 0° to +50°C (RH 5%-80%, no condensation)



## TECHNICAL DATA

VIR Code	P. Supply	Control	Torque	Travel Time [sec]	Auxiliary switch
KAM980L00.800	230VAC	2 points	10Nm	30"	NO
KAM980L01.800	230VAC	2 points	10Nm	30"	YES
KAM980L02.800	24VAC	2 points	10Nm	30"	NO
KAM980L03.800	24VAC	2 points	10Nm	30"	YES
KAM980L04.800	24VDC	2/3 points	6Nm	5"	YES
KAM980L05.800	24V AC/DC	0-10V	10Nm	60"	YES

## DIMENSIONS

Dimensions in mm, wight 0,5Kg

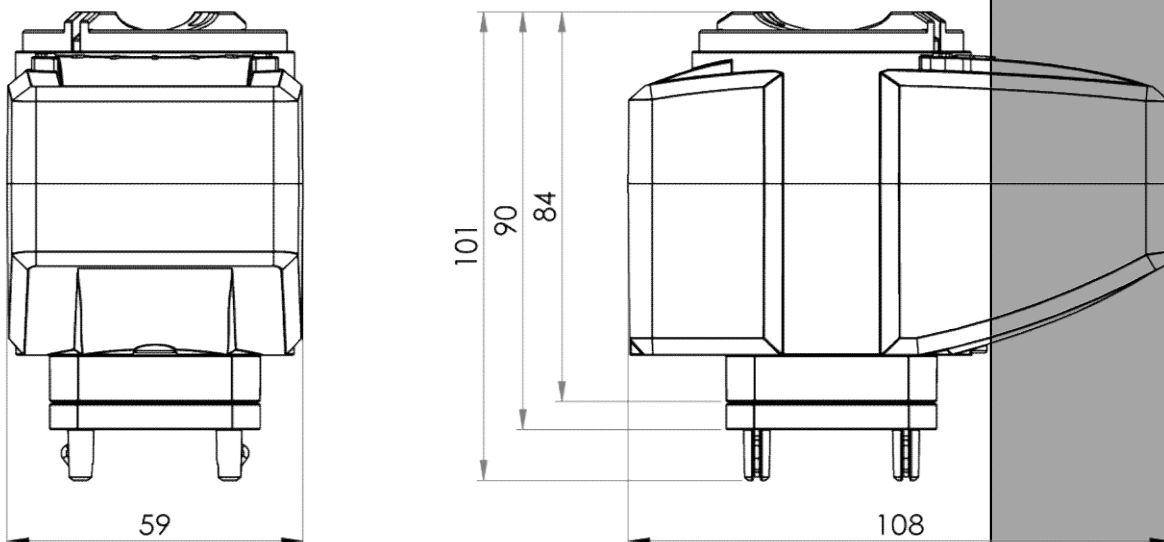

240527

# WIRING DIAGRAMS

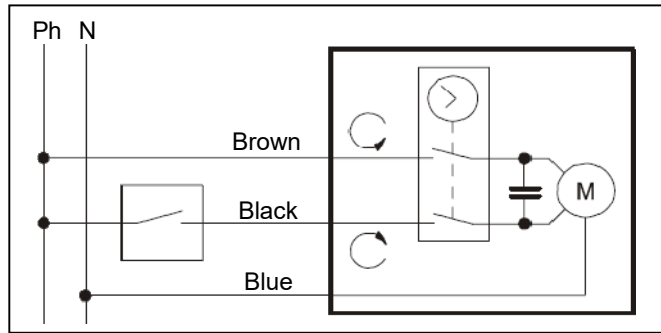

2 points control

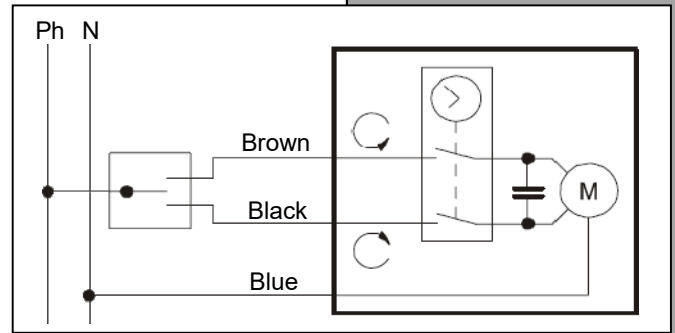

3 points control

Ref.	Designation
N	Wiring to neutral
Ph	Wiring to phase
+	Wiring to + pole
-	Wiring to - pole

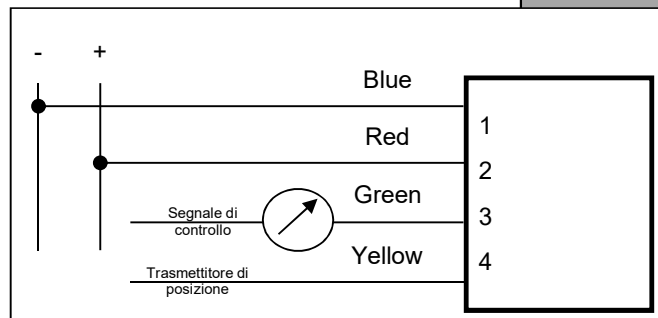

0 -10V control signal

# INSTALLATION

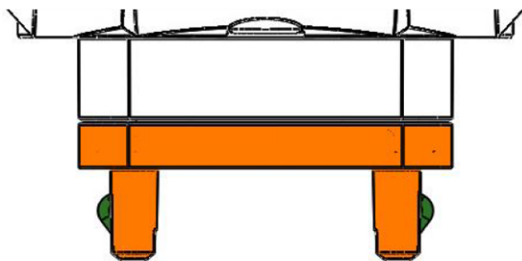

## Movimentazione manuale semplificata:

sistema integrato di sblocco manuale che consente di movimentare la valvola con una sola mano, senza necessità di disconnettere l'attuatore dalla valvola e senza l'ausilio di attrezzi.

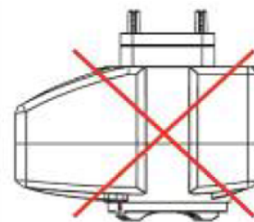
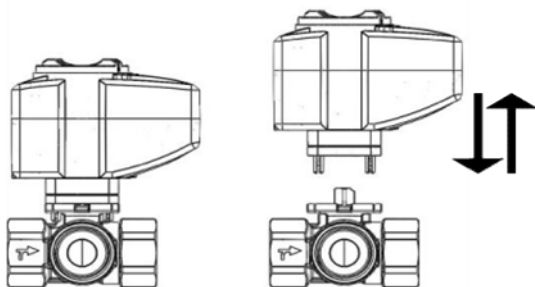

NO



Via Circonvallazione, 10  
13018 Valduggia (VC), Italy  
Tel: +39 0163 47891  
Fax: +39 0163 47895  
www.vironline.com