

100, 100LK

Bronze Metal Sealed Gate Valve



Via Circonvallazione, 10
13018 Valduggia (VC), Italy
Tel: +39 0163 47891
Fax: +39 0163 47895
www.vironline.com



Bronze gate valve
Threaded F/F (ISO 7/1 Rp)
EN12288/B (ex BS5154/B) compliant
Air testing according to EN12266-1
Non rising blow-out proof stem
Adjustable packing
Metal seal

Available in the following versions:

- Fig. 100, with aluminum handwheel
 - Fig. 100LK, with lockshield (require dedicated tool to be operated)
- WRAS and TR CU 010 compliant

PN20 (Max 20bar up to 100°C, max 10bar at 170°C)
Free of CE marking (cat. according to Art. 4.3 Dir. 2014/68/EU)

Working conditions

- Suitable for: water, -10°C to +170°C
below 0°C only for water with added antifreeze fluids
- Not suitable for: gases group 1 & 2, liquids group 1 (Dir. 2014/68/EU)



PARTLIST

N.	Part	Material	Norm
1	Body	Bronze	EN1982 CC491K
2	Wedge	DZR Brass	EN12164 CW602N
3	Ring	Brass	EN12164 CW617N
4	Stem	DZR Brass	EN12164 CW602N
5	Gasket	PTFE	-
6	Bonnet	Bronze	EN1982 CC491K
7	Packing ring	Graphite	-
8	Packing nut	Brass	EN12164 CW617N
9	Handwheel	Aluminum	-
10	Disc	Aluminum	-
11	Nut	Steel	EN10025 Fe42

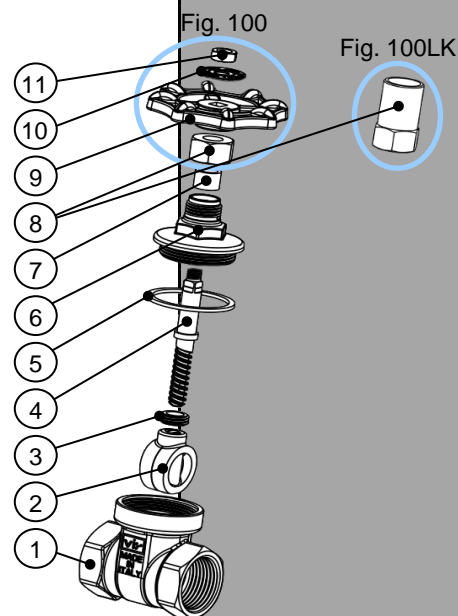

DIMENSIONS

DN	T	L	C	P	H ¹	ØV	ØD-□Q	K _v	Weight ¹
		[mm]	[mm]	[mm]	[mm]	[mm]	[mm]	[m ³ /h]	[g]
015	½"	49	15,5	13	66/68	60	13,5-□6	9	240/230
020	¾"	52	16,5	19	77/77	60	13,5-□7	20	320/310
025	1"	61	19,5	25	89/85	70	13,5-□7	35	485/465
032	1¼"	70	21,5	32	111/104	85	16,0-□7	62	760/730
040	1½"	72	21,5	38	124/115	85	18,8-□8	104	1120/1080
050	2"	84	26	49	143/134	100	18,8-□8	169	1615/1565

¹Fig. 100 / Fig. 100LK

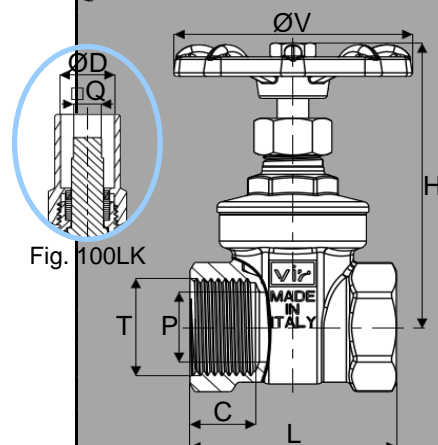

240903