

9500 series

Variable Orifice Bronze Double Regulating Valve



Via Circonvallazione, 10
13018 Valduggia (VC), Italy
Tel: +39 0163 47891
Fax: +39 0163 47895
www.vironline.com



Variable orifice bronze double regulating valve
Threaded F/F (ISO 228/1)
Design according to BS7350
Tolerance on nominal K_v for completely open valve $\pm 5\%$
(see flow measurement section, test according to BS7350)
Available in the following versions:

- Fig. 9500, with threaded and plugged drains ($\frac{1}{4}$ " ISO 7/1Rp) (allow later mounting of test points)
 - Fig. 9505, with test points
 - Fig. 9506, with test points (high pressure TP with drain)
- WRAS, STF and TR CU 010 compliant

PN25 (Max 25bar up to 110°C, max 20bar above)
Free of CE marking (cat. according to Art. 4.3 Dir. 2014/68/EU)

Working conditions

- Suitable for: water, -10°C to $+130^{\circ}\text{C}$
below 0°C only for water with added antifreeze fluids
over 100°C only for water with added anti-boiling fluids
(Ethylene glycol or propylene glycol mixtures up to 50% may be used)
- Not suitable for: gases group 1 & 2, liquids group 1 (Dir. 2014/68/EU)

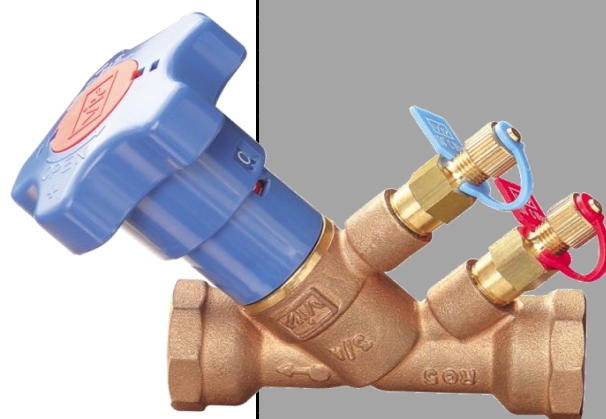

PARTLIST

N.	Part	Material	Norm
1	Body	Bronze	EN1982 CC491K
2	Balancing cone ¹	DZR Brass	EN12164 CW602N
3	Gasket disc	PTFE	-
4	Disc ²	DZR Brass	EN12164 CW602N
5	Disc O-ring ²	EPDM Perox	-
6	Disc stem	DZR Brass	EN12164 CW602N
7	Stem O-ring	EPDM Perox	-
8	Union ²	DZR Brass	EN12165 CW602N
9	Stem	Brass	EN12164 CW617N
10	Bonnet	DZR Brass	EN12164 CW602N
11	Stop spring ring	Spring Steel	-
12	Screw	Steel	-
13	Handwheel	ABS (blue)	-
14	Nut	Zinc plated steel	EN10025 Fe42
15	Test point / plug	DZR Brass ³	EN12164 CW602N

¹As a single piece as part of the stem for DN10

²Only on DN32, DN40 and DN50

³Test points with EPDM gaskets and polypropylene ties

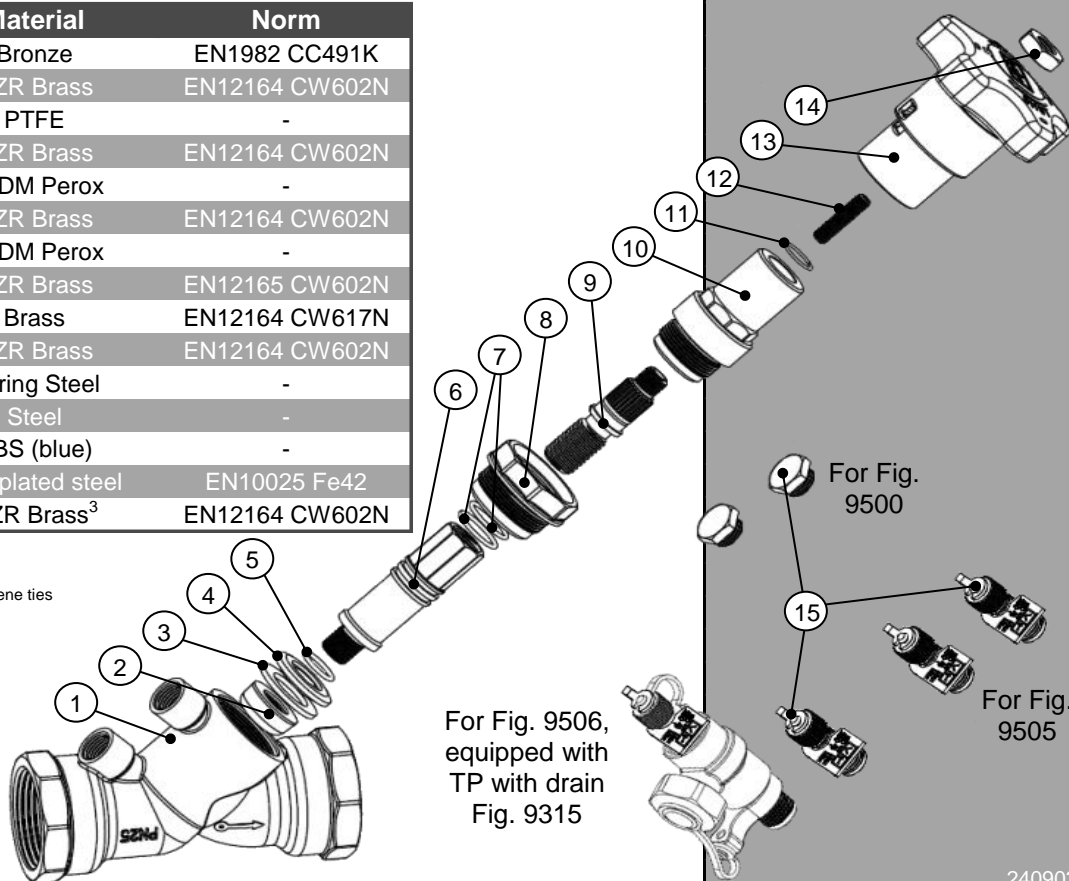

For Fig. 9506,
equipped with
TP with drain
Fig. 9315

For Fig.
9505

DIMENSIONS

DN	G	H [mm]	L [mm]	B [mm]	ØV [mm]	Wgt [g]	Flow range [l/s]
010	3/8"	91,0	77,0	12,5	70	474	0,017-0,074
015	1/2"	90,0	90,0	17,5	70	505	0,062-0,148 ¹
020	3/4"	90,0	102,0	18,0	70	565	0,138-0,325 ¹
025	1"	90,0	110,0	19,0	70	705	0,258-0,603 ¹
032	1 1/4"	116,0	121,0	22,0	70	1005	0,540-1,250 ¹
040	1 1/2"	116,0	142,0	24,0	70	1355	0,810-1,88 ¹
050	2"	116,0	161,0	27,0	70	1925	1,52-3,51 ¹

¹Suggested flow range applicability (BS7350)

If used with measuring manometers different from those proposed by VIR please verify that sensibility of the measuring device is compatible with indicated minimum flow (see flow measurement paragraph)

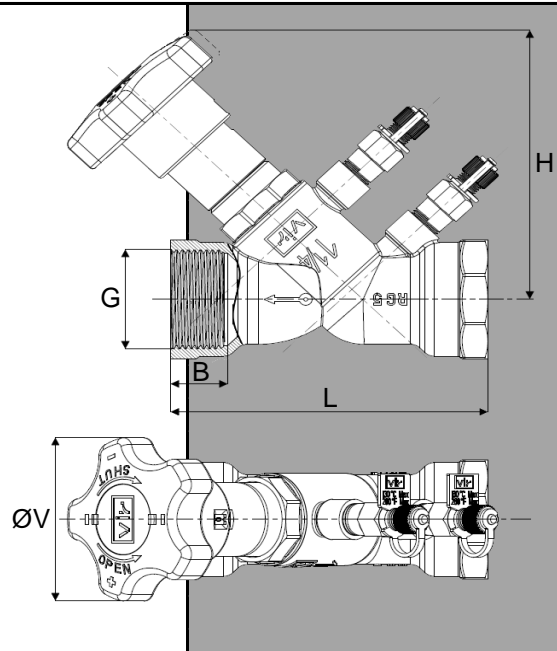

FLOW MEASUREMENT

Handwheel position	K _v [m³/h @ 1bar]						
	010	015	020	025	032	040	050
0,5	0,09	0,37	0,40	1,40	1,40	2,70	3,90
0,6	0,11	0,40	0,44	1,58	2,12	2,85	4,23
0,7	0,13	0,44	0,50	1,70	2,60	3,00	5,00
0,8	0,15	0,47	0,57	1,80	2,92	3,16	5,97
0,9	0,17	0,52	0,64	1,89	3,13	3,32	6,94
1,0	0,19	0,55	0,70	2,00	3,30	3,50	7,80
1,1	0,21	0,60	0,75	2,12	3,42	3,69	8,47
1,2	0,24	0,64	0,77	2,26	3,56	3,94	8,98
1,3	0,26	0,68	0,80	2,40	3,70	4,10	9,40
1,4	0,30	0,71	0,84	2,50	3,90	4,29	9,98
1,5	0,33	0,75	0,90	2,60	4,10	4,50	10,60
1,6	0,37	0,78	0,95	2,74	4,23	4,68	11,32
1,7	0,40	0,81	1,00	2,90	4,40	4,90	12,10
1,8	0,43	0,87	1,07	3,06	4,61	5,23	12,94
1,9	0,47	0,91	1,14	3,27	4,86	5,62	13,84
2,0	0,50	0,94	1,20	3,50	5,10	6,10	14,80
2,1	0,53	0,97	1,25	3,76	5,53	6,67	15,80
2,2	0,57	1,00	1,29	4,03	5,95	7,37	16,84
2,3	0,60	1,06	1,30	4,30	6,50	8,20	17,90
2,4	0,63	1,10	1,39	4,56	6,97	9,05	18,92
2,5	0,66	1,18	1,50	4,80	7,60	10,00	19,90
2,6	0,69	1,26	1,57	4,96	8,13	10,78	20,81
2,7	0,71	1,35	1,70	5,10	8,60	11,60	21,70
2,8	0,74	1,49	1,85	5,24	9,32	12,53	22,45
2,9	0,78	1,63	2,02	5,37	9,86	13,38	23,20
3,0	0,81	1,75	2,20	5,50	10,40	14,10	23,90
3,1	0,84	1,93	2,43	5,60	10,66	15,00	24,62
3,2	0,87	2,08	2,67	5,71	10,86	15,74	25,29
3,3	0,90	2,25	2,90	5,80	10,90	16,60	25,90
3,4	0,91	2,35	3,15	5,91	11,06	17,06	26,56
3,5	0,92	2,44	3,40	6,00	11,20	17,60	27,20
3,6	0,93	2,46	3,61	6,10	11,25	18,13	27,74
3,7	0,94	2,50	3,80	6,18	11,31	18,57	28,30
3,8	0,95	2,55	3,96	6,26	11,47	18,94	28,83
3,9	0,96	2,60	4,06	6,34	11,69	19,24	29,34
4,0	0,97	2,67	4,10	6,40	12,00	19,50	29,80

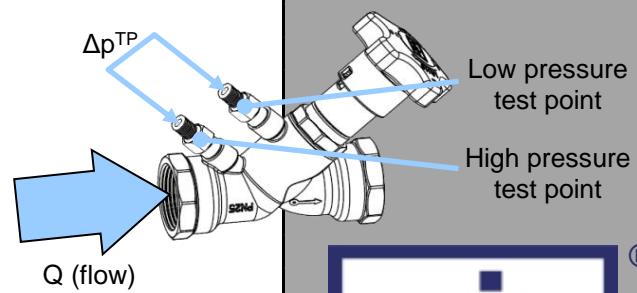
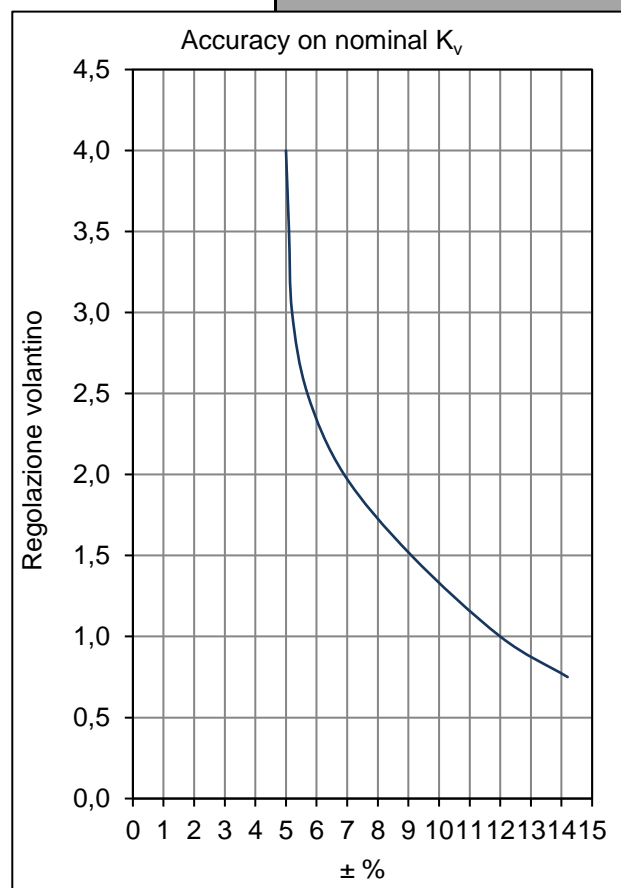

$$Q = \frac{K_v \cdot \sqrt{\Delta p^{TP}}}{36}$$

Formula linking flow Q (in l/s) and Δp measured at test points (in kPa). K_v depends on handwheel position as indicated on table.
 Minimum flow that can be measured for each diameter may be calculated by using in the formula minimum Δp that can be measured by used manometer.
 Valves are anyway designed for best performances when used on range previously suggested and as indicated by BS7350.



Via Circonvallazione, 10
 13018 Valduggia (VC), Italy
 Tel: +39 0163 47891
 Fax: +39 0163 47895
www.vironline.com

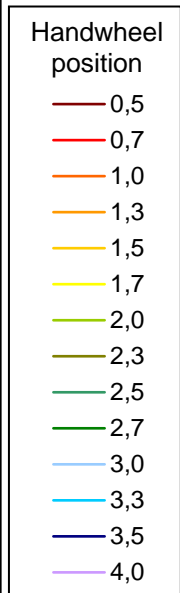
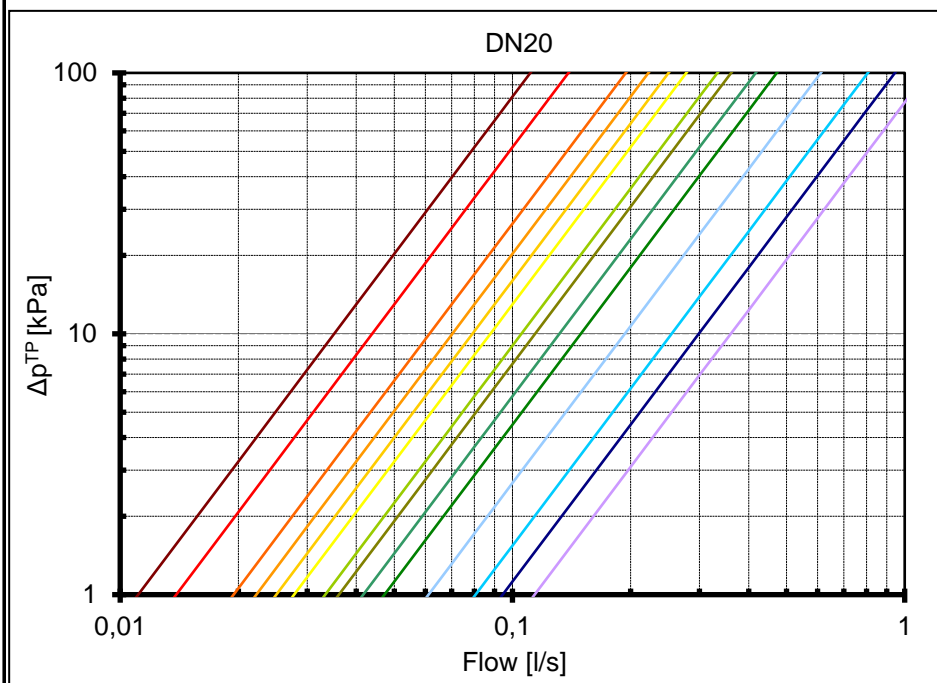
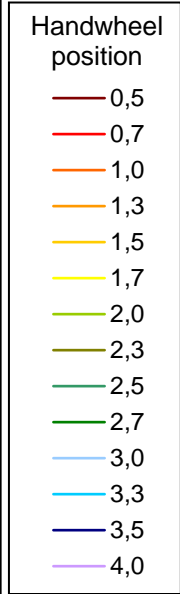
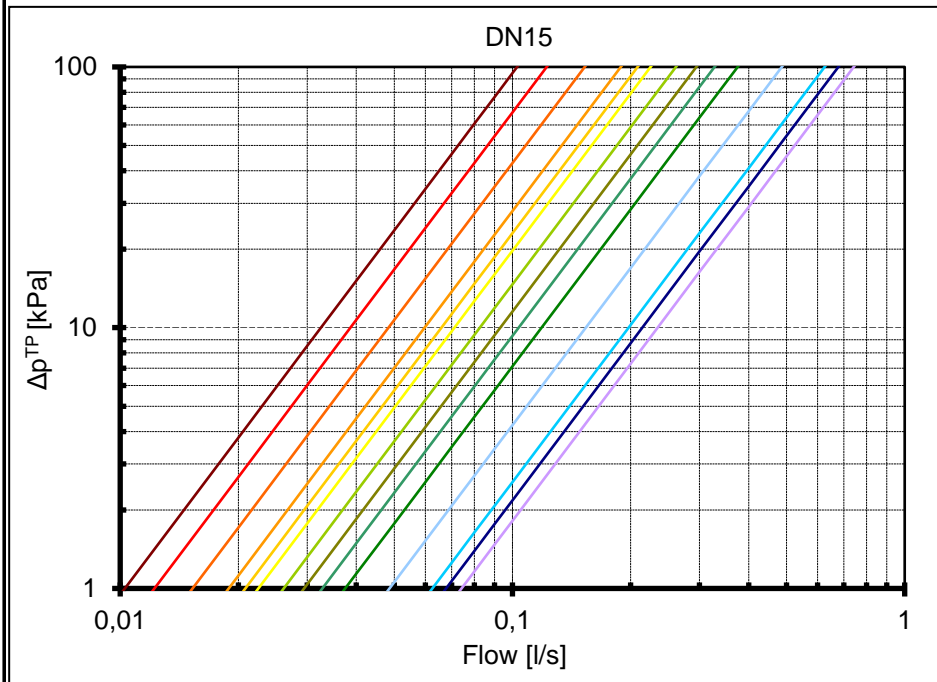
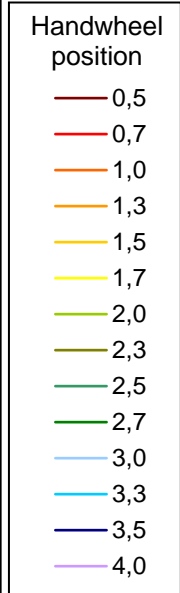
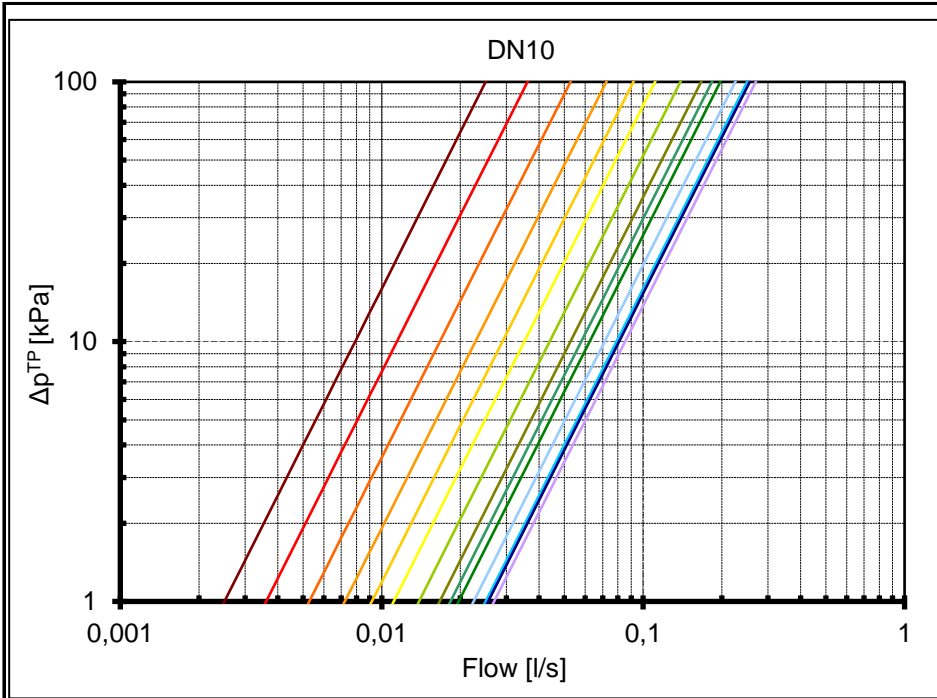

Via Circonvallazione, 10
 13018 Valduggia (VC), Italy
 Tel: +39 0163 47891
 Fax: +39 0163 47895
www.vironline.com

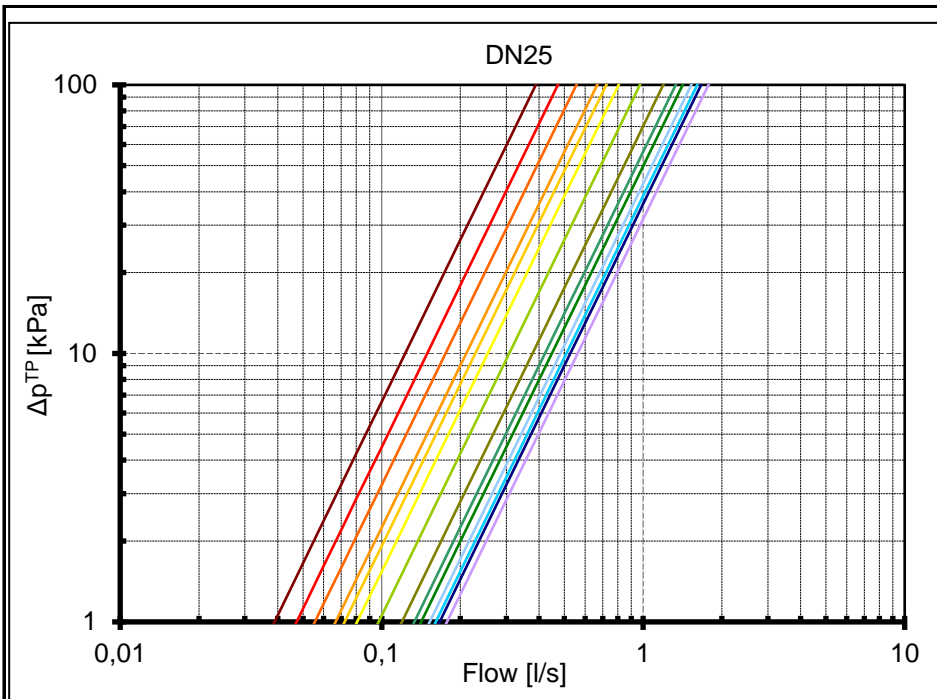

- Handwheel position
- 0,5
 - 0,7
 - 1,0
 - 1,3
 - 1,5
 - 1,7
 - 2,0
 - 2,3
 - 2,5
 - 2,7
 - 3,0
 - 3,3
 - 3,5
 - 4,0

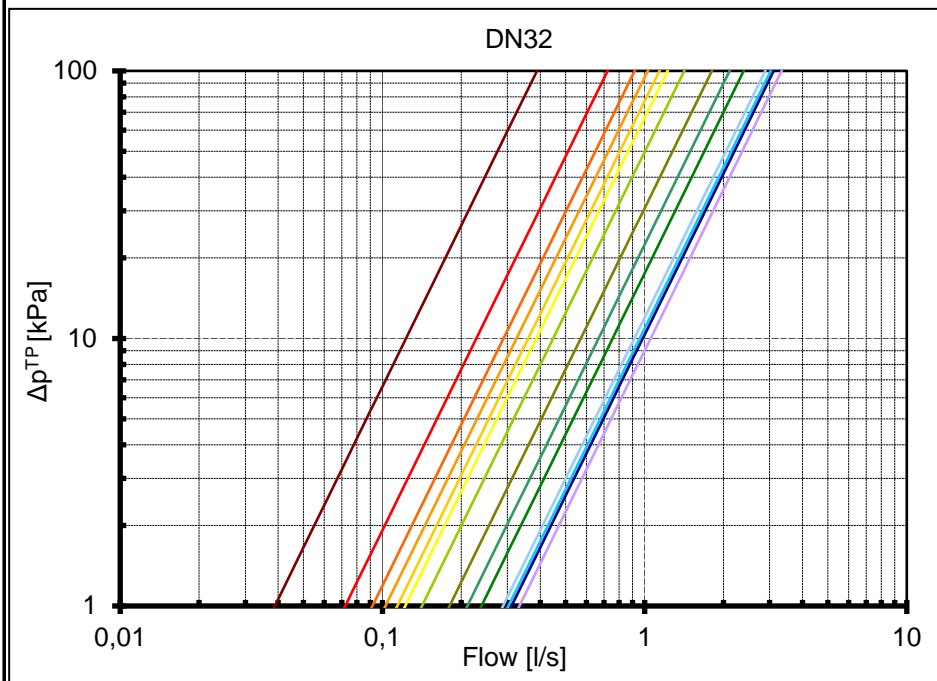

- Handwheel position
- 0,5
 - 0,7
 - 1,0
 - 1,3
 - 1,5
 - 1,7
 - 2,0
 - 2,3
 - 2,5
 - 2,7
 - 3,0
 - 3,3
 - 3,5
 - 4,0

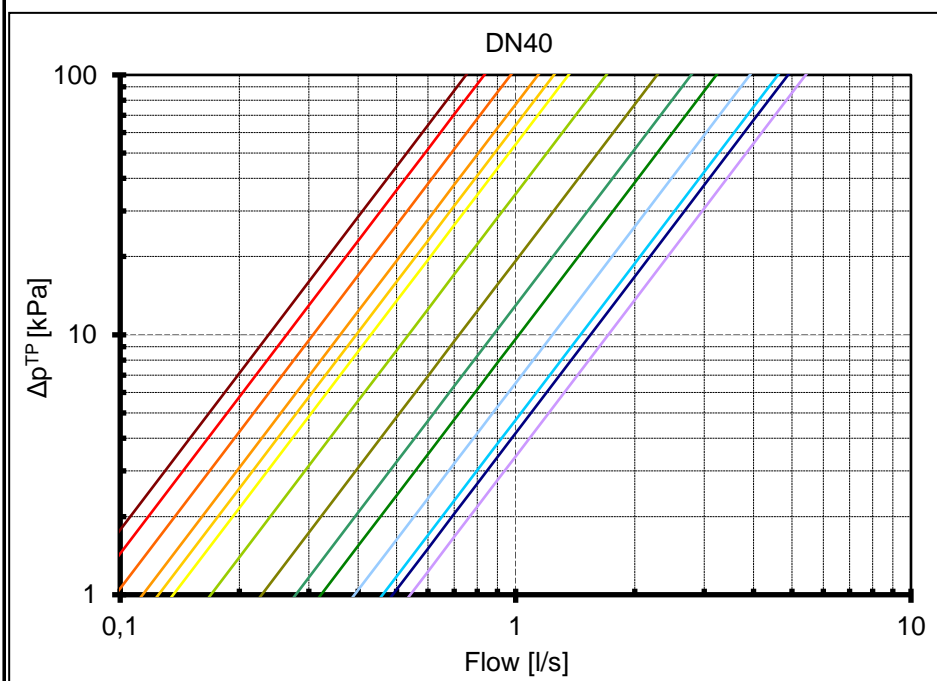

- Handwheel position
- 0,5
 - 0,7
 - 1,0
 - 1,3
 - 1,5
 - 1,7
 - 2,0
 - 2,3
 - 2,5
 - 2,7
 - 3,0
 - 3,3
 - 3,5
 - 4,0



Via Circonvallazione, 10
 13018 Valduggia (VC), Italy
 Tel: +39 0163 47891
 Fax: +39 0163 47895
www.vironline.com

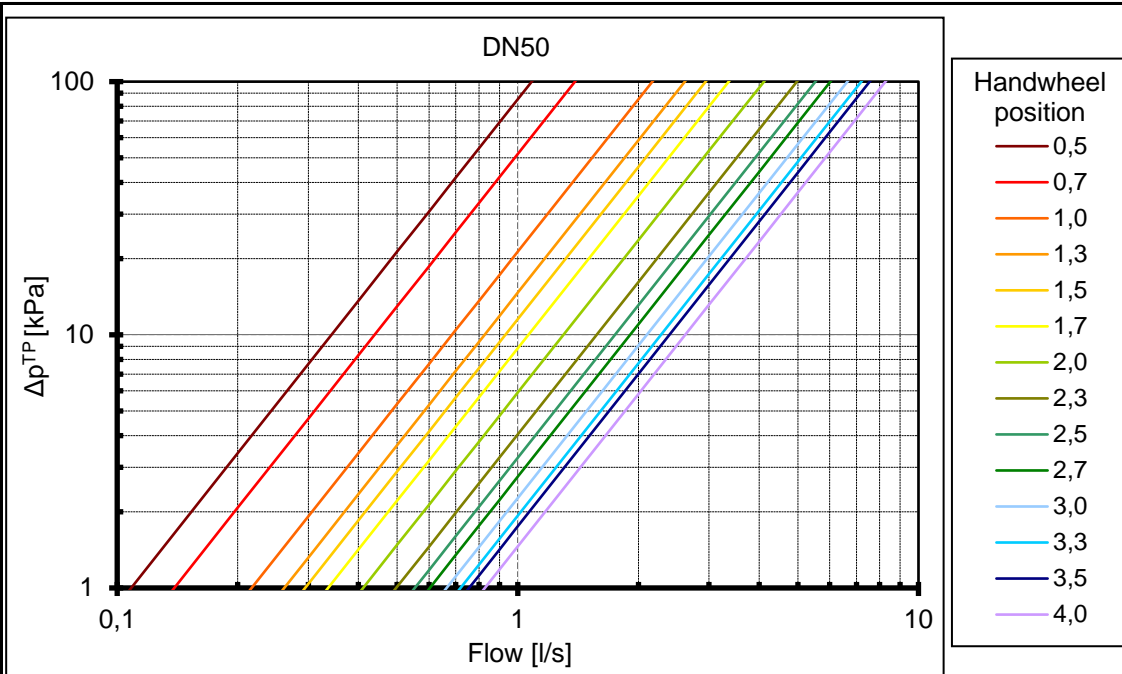

HEADLOSS CALCULATION

Handwheel position	K _v [m ³ /h @ 1bar]						
	010	015	020	025	032	040	050
0,5	0,09	0,37	0,40	1,40	1,40	2,70	3,90
0,6	0,11	0,40	0,44	1,58	2,12	2,85	4,23
0,7	0,13	0,44	0,50	1,70	2,60	3,00	5,00
0,8	0,15	0,47	0,57	1,80	2,92	3,16	5,97
0,9	0,17	0,52	0,64	1,89	3,13	3,32	6,94
1,0	0,19	0,55	0,70	2,00	3,30	3,50	7,80
1,1	0,21	0,60	0,75	2,12	3,42	3,69	8,47
1,2	0,24	0,64	0,77	2,26	3,56	3,94	8,98
1,3	0,26	0,68	0,80	2,40	3,70	4,10	9,40
1,4	0,30	0,71	0,84	2,50	3,90	4,29	9,98
1,5	0,33	0,75	0,90	2,60	4,10	4,50	10,60
1,6	0,37	0,78	0,95	2,74	4,23	4,68	11,32
1,7	0,40	0,81	1,00	2,90	4,40	4,90	12,10
1,8	0,43	0,87	1,07	3,06	4,61	5,23	12,94
1,9	0,47	0,91	1,14	3,27	4,86	5,62	13,84
2,0	0,50	0,94	1,20	3,50	5,10	6,10	14,80
2,1	0,53	0,97	1,25	3,76	5,53	6,67	15,80
2,2	0,57	1,00	1,29	4,03	5,95	7,37	16,84
2,3	0,60	1,06	1,30	4,30	6,50	8,20	17,90
2,4	0,63	1,10	1,39	4,56	6,97	9,05	18,92
2,5	0,66	1,18	1,50	4,80	7,60	10,00	19,90
2,6	0,69	1,26	1,57	4,96	8,13	10,78	20,81
2,7	0,71	1,35	1,70	5,10	8,60	11,60	21,70
2,8	0,74	1,49	1,85	5,24	9,32	12,53	22,45
2,9	0,78	1,63	2,02	5,37	9,86	13,38	23,20
3,0	0,81	1,75	2,20	5,50	10,40	14,10	23,90
3,1	0,84	1,93	2,43	5,60	10,66	15,00	24,62
3,2	0,87	2,08	2,67	5,71	10,86	15,74	25,29
3,3	0,90	2,25	2,90	5,80	10,90	16,60	25,90
3,4	0,91	2,35	3,15	5,91	11,06	17,06	26,56
3,5	0,92	2,44	3,40	6,00	11,20	17,60	27,20
3,6	0,93	2,46	3,61	6,10	11,25	18,13	27,74
3,7	0,94	2,50	3,80	6,18	11,31	18,57	28,30
3,8	0,95	2,55	3,96	6,26	11,47	18,94	28,83
3,9	0,96	2,60	4,06	6,34	11,69	19,24	29,34
4,0	0,97	2,67	4,10	6,40	12,00	19,50	29,80

$$\Delta p = \left(\frac{36 \cdot Q}{K_v} \right)^2$$

Formula linking flow Q (in l/s) and theoretical valve headloss Δp (in kPa). K_v depends on handwheel position as indicated on table.

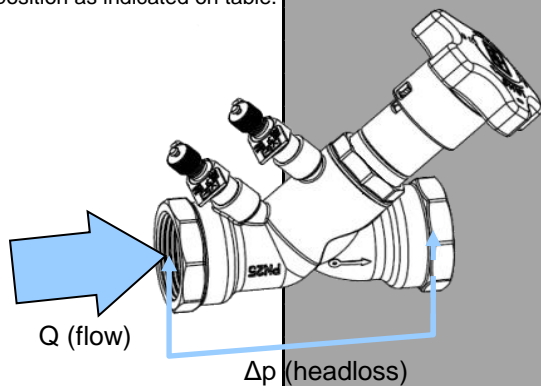

Via Circonvallazione, 10
13018 Valduggia (VC), Italy
Tel: +39 0163 47891
Fax: +39 0163 47895
www.vironline.com

Copy of the table presented in flow measurement paragraph
Δp (headloss) approximately equal to Δp^{TP}

INSTALLATION

To obtain the best performances valve must be installed on a pipe with its same nominal size preceded and followed by straight pipe lengths as per figure indications.

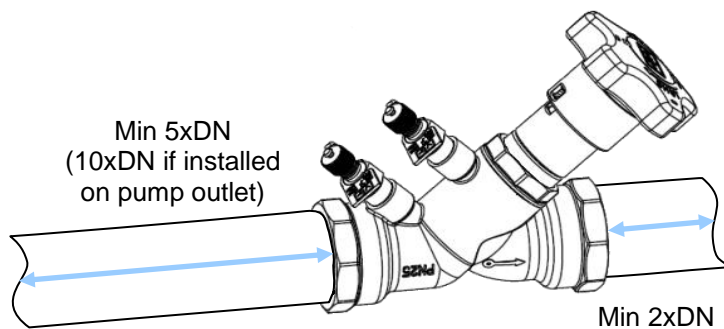

Via Circonvallazione, 10
13018 Valduggia (VC), Italy
Tel: +39 0163 47891
Fax: +39 0163 47895
www.vironline.com

PRESETTING

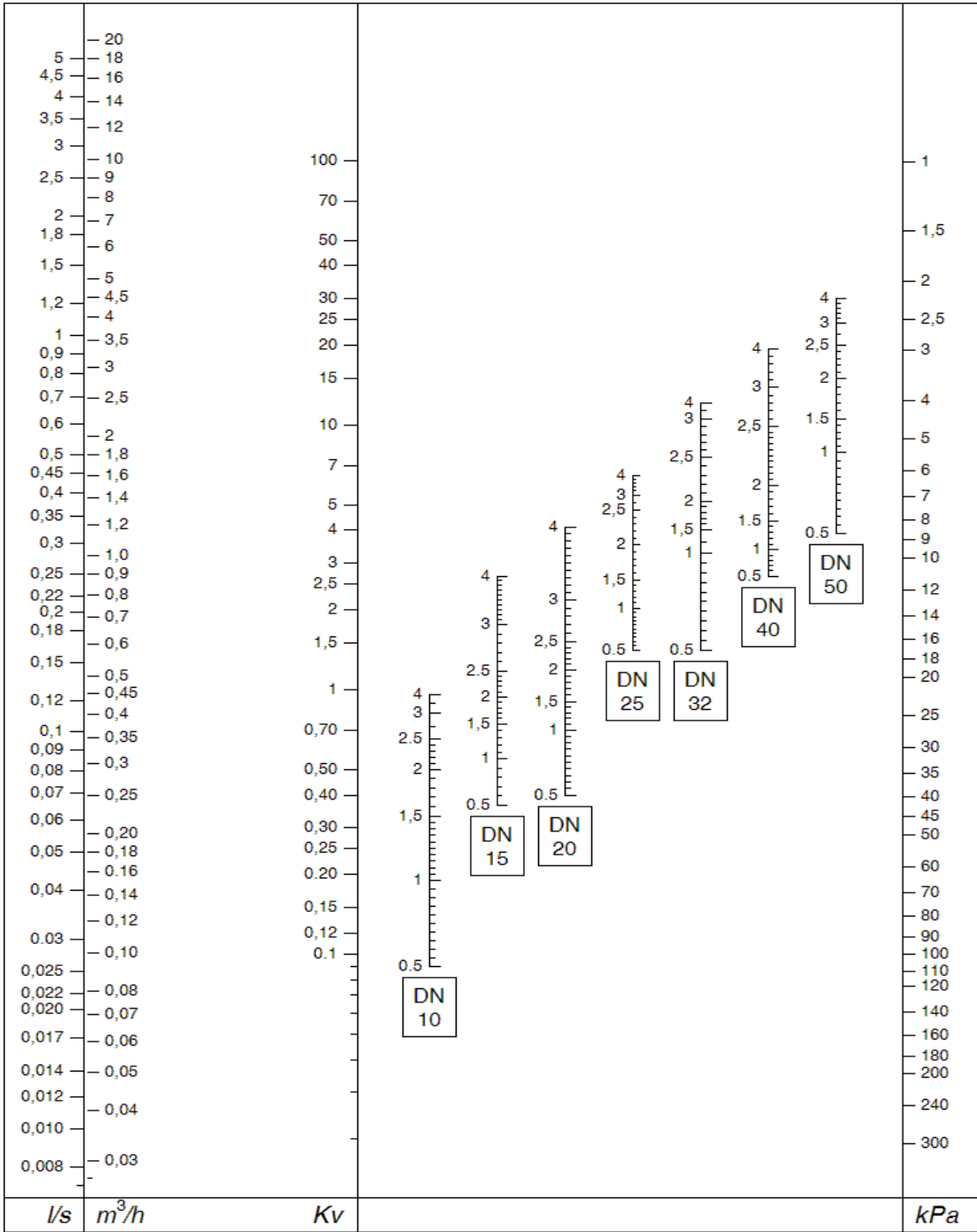

By using diagram above is possible to esteem the presetting position of the valve with given design flowrate and headloss:

- 1) draw a straight line joining design flowrate and design headloss;
- 2) determine design K_v value as intersection of drawn line and K_v axis;
- 3) draw a straight horizontal line from intersection previously identified and the specific valve DN Axis;
- 4) intersection determines handwheel position to use for presetting.

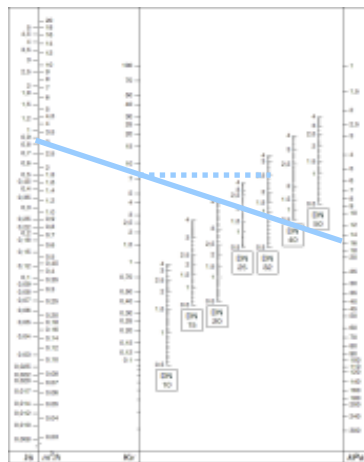

In the example for a design flowrate of $3\text{m}^3/\text{h}$ and design Δp 16kPa handwheel position of 2,5 is determined for a DN32 valve



Via Circonvallazione, 10
13018 Valduggia (VC), Italy
Tel: +39 0163 47891
Fax: +39 0163 47895
www.vironline.com